



Battery service life:

The Teconnex Advanced 100 is a 12.8V 100Ah LiFePO₄ battery. Designed to offer 3000 cycles^[1] (equivalent to up to 10 years^[2] of use). This can be up to 10 times the life of a typical lead-acid battery.

At 11.4kg the Advanced 100 weighs approximately half of the weight of a typical lead-acid battery. Benefit from performance advantages way beyond other battery types. Enjoy 12.8V including when operating at high discharge levels.

Enjoy a minimum of 12V even at high discharge rates of up to 100A not only when the Advanced 100 is fully charged, but throughout each use including as the battery approaches a complete discharge.

Safety protection:

The Teconnex Power Advanced 100 has an in-built Battery Management System (BMS) to protect the unit from overcharging, overheating, short circuit, excess discharging, long storage cell failure and cold storage cell failure.

Robust environmental safety features have been designed within the Advanced 100, providing high levels of LiFePO₄ product assurance and safety protection for the owner.

1. We define a cycle as when the product completes a combined charge and discharge of at least 70% of the specified original nominal energy capacity.
2. Our specifications are based on the Advanced 100 performing a maximum of 300 cycles in any measured 12 month period.

Electrical Specifications

Nominal Voltage	12.8V
Nominal Capacity at 25°C	100Ah
Depth of Discharge (DoD)	>95% ^[3] (plus an operational variance allowance of up to ± 3%) ^[4]
Resistance at 50% State of Charge (SoC)	≤30mΩ
Nominal Energy at 25°C	1280Wh

[3] This DoD value is at time of manufacture. DoD capacity will naturally decrease over time. DoD capacity is also subject to type of usage performed and operating environment factors.

[4] An operational variance allows for individual cell fluctuations, BMS balancing, BMS safety operations, specific use case requirements and variances in temperature and humidity during product lifetime operation.

Mechanical Specifications

Dimensions (L x W X H)	328mm x 172.5mm x 217.3mm
Weight	11.4 Kg
Terminal Connections	M8 thread
Terminal Torque	11-13 Nm
Enclosure Protection	IP43
Cell Type & Chemistry	Prismatic LiFePO4 100Ah 3.2V

Discharge Specifications

Max Continuous Discharge Current	100A
Peak Discharge Current	105A for 10 seconds
BMS Low Discharge Voltage cut-off	10.8V after 2 seconds at a pack level or 2.7V after 2 seconds at an individual cell level
Recommended Discharge Current	50A
Operating temperature less than 75% relative humidity	Between -10°C to +52°C*

Charge Specifications

Max Continuous Charge Current	100A
Peak Charge Current	105A for 10 Seconds
Recommended Charge Current	50A to 20A (use 20A if extending the product life is paramount over time to charge)
Operating temperature less than 75% relative humidity	Between 0.5°C and 52°C*

Environmental & Storage condition

Operating temperature less than 75% relative humidity	Store the Advanced 100 in a safe and dry location with an ambient temperature between -20 to +25°C* The Advanced 100 has a self discharge rate of 0.35% ^[5]
---	---

*Note: these temperatures are set to ensure the Advanced 100 LiFePO4 battery cells do not exceed operational specification parameters.

[5] Based on an uninterrupted 30 day period at a constant temperature of 25°C

Abbreviation	Meaning
V	Voltage
A	Amps
Ah	Amps per hour
Nm	Newton-metre

Abbreviation	Meaning
mΩ	Milliohm
Wh	Watts per hour
Kg	Kilogram
°C	Degrees Celsius



Dimensional Specifications

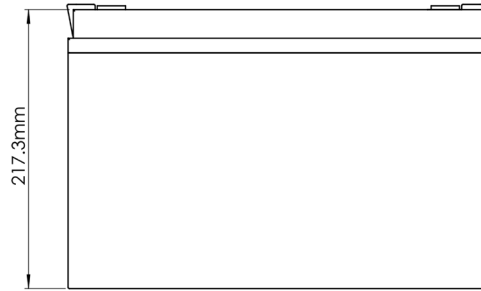
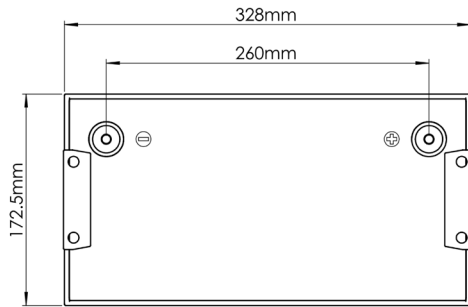

Performance Characteristics

Note: C = rate of charge / rate of discharge.

A 0.5C charge is a 50A charge and a 1C charge is a 100A charge.

A 0.5C discharge is 50A discharge and a 1C discharge is 100A discharge.

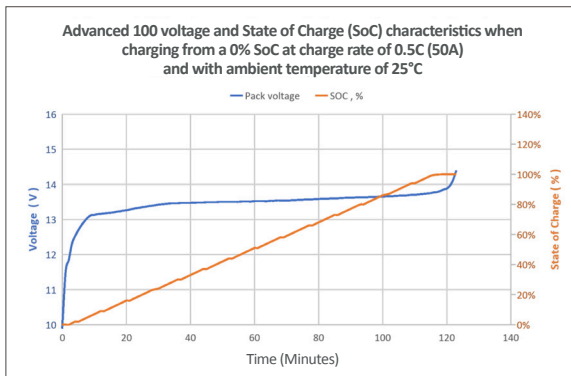
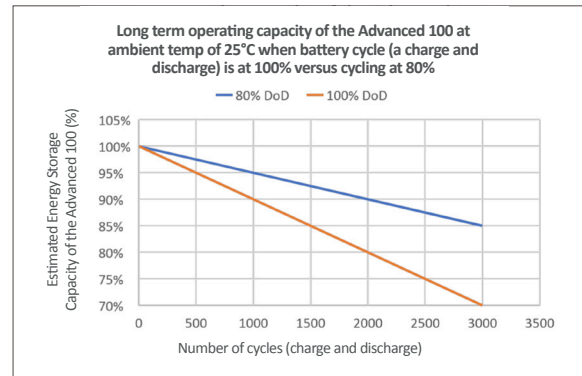
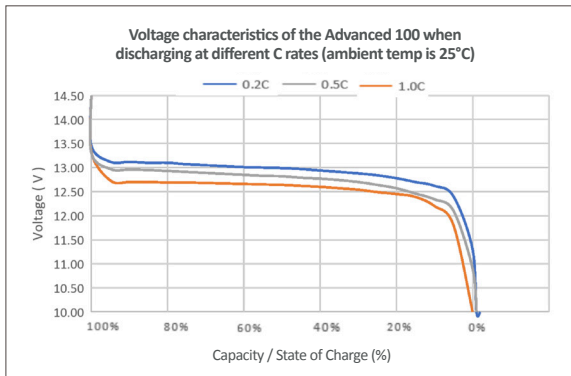
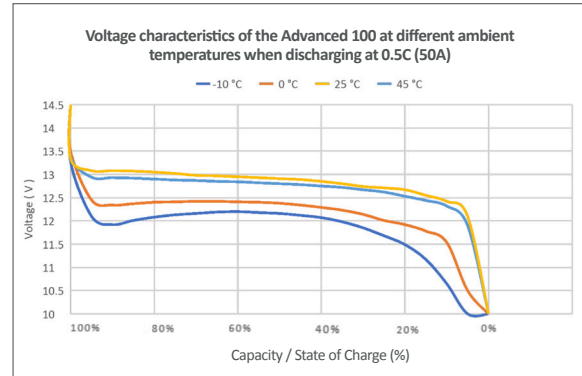
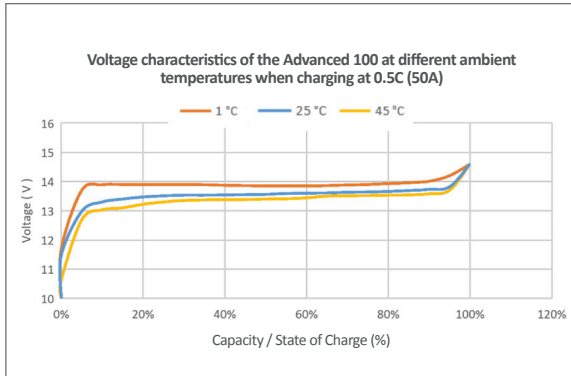

The C-rate is the charge or discharge rate that a battery is charged or discharged at.

For example, a C or charge rate of 1C means a charge rate of 100A.

Therefore, the Teconnex Power Advanced 100 would be charged from 0% to 100% in one hour as it is a 100Ah leisure battery.

A charge rate of 0.5C is a rate of 50A. In this situation the Advanced 100 would be charged from 0% to 100% in two hours.

A charge rate of 0.2C is a rate of 20A. If a fully charged Advanced 100 discharges electricity at a rate of 0.2C it would take approximately 5 hours before the Advanced 100 would reach empty (that is a 0% State of Charge or SoC).

